

**PROFILE, SZNURY
I KSZTAŁTKI Z GUMY,
SILIKONU, GUMY
POROWATEJ
I SILIKONU
SPIENIONEGO
(POROWATEGO)**

specGUM SP. ZO.O.
93-231 Łódź, ul. Gen. J. Dąbrowskiego 238
tel.: 42 236 14 15, fax: 42 682 13 00
info@specgum.pl, www.specgum.pl
NIP: 729-26-49-106, Regon: 100545771
KRS: 0000310107

Profile listwowe

Lista nr 528

Ostatnia zmiana: 16.09.2004

SL

Objaśnienie oznaczeń

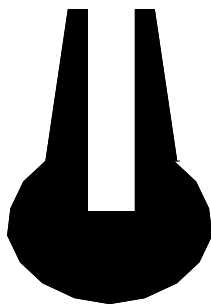

SL 9999

oznacza

nr profilu

Qualität

CR	Neoprene
EP	EPDM
NBR	Perbunan
NK	Naturkautschuk
Si	Silikon
SPS	Silikonschaum
FPM	VITON®
PVC	Weich-PVC
EVA	Ethylenvinylacetat
SBR	Buna (Styrol-Butadien)

Farbe

s	schwarz
g	grau
w	weiß
az	anthrazit
bg	beige
br	braun
hg	hellgrau
rb	rotbraun
t	transparent
r	rot
x	Farbe wählbar

VITON® = Eingetragenes Warenzeichen der Firma DuPont

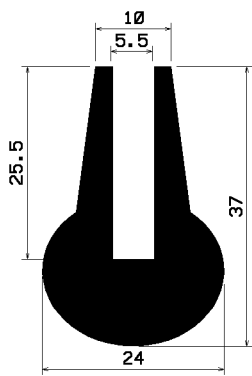

SL2017

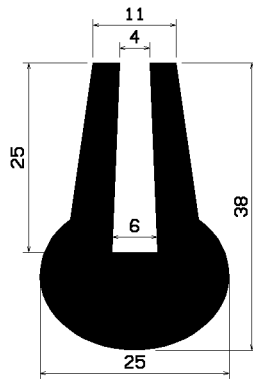

SL2018

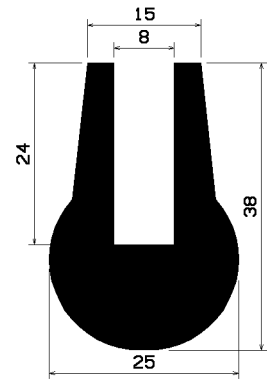

SL2019

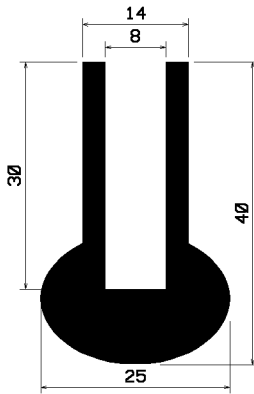

SL2020

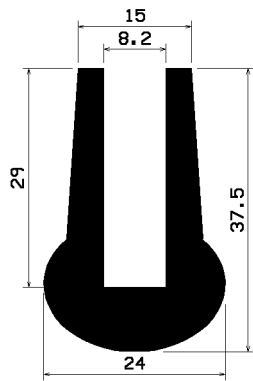

SL2021

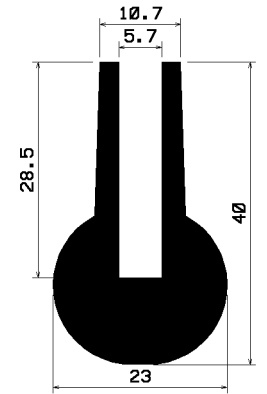

SL2022

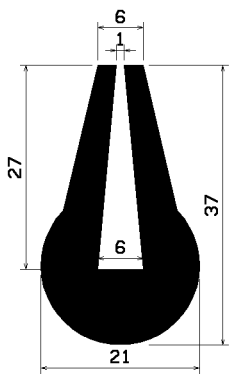

SL2023

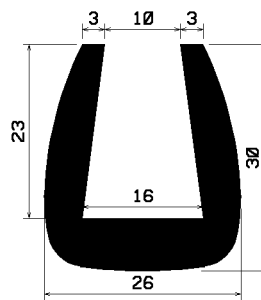

SL2024

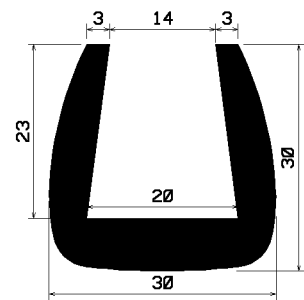

SL2025

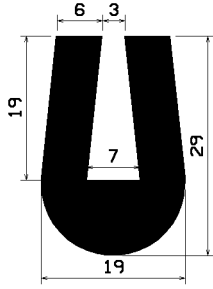

TU1-112

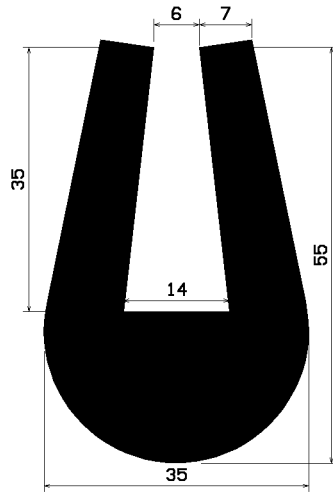

TU1-338

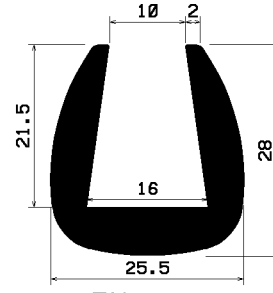

TU1-734

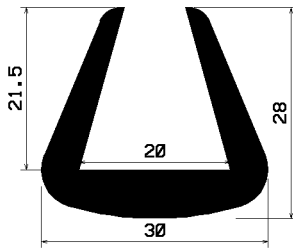

TU1-846

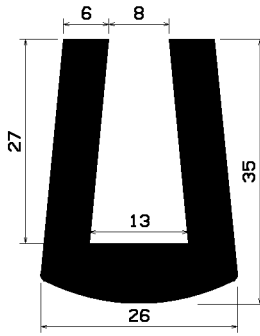

TU1-1202

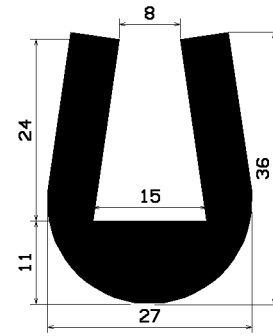

TU1-1617

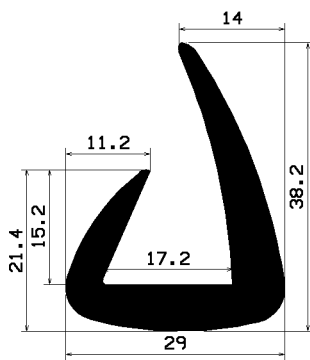

TU1-1946