

PROFILE, SZNURY  
I KSZTAŁTKI Z GUMY,  
SILIKONU, GUMY  
POROWATEJ  
I SILIKONU  
SPIENIONEGO  
(POROWATEGO)

specGUM Sp. z o.o.  
93-231 Łódź, ul. Gen. J. Dąbrowskiego 238  
tel.: 42 236 14 15, fax: 42 682 13 00  
info@specgum.pl, www.specgum.pl  
NIP: 729-26-49-106, Regon: 100545771  
KRS: 0000310107

# Profile **szybowe** i rozpieracze Lista nr 578

Ostatnia zmiana: 04.01.2008



KL

# Objaśnienie oznaczeń

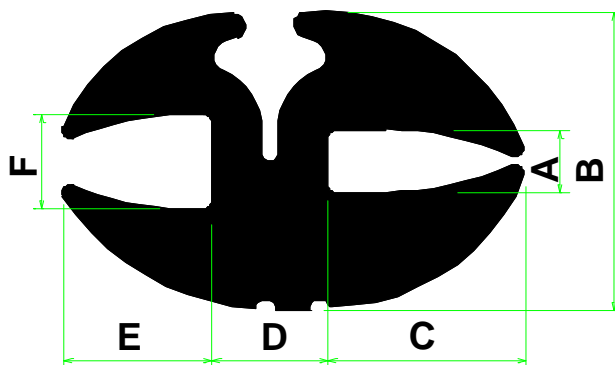

**KL 9999**

oznacza

*nr profilu*

**EP / s / 9999 / (9998)**

oznacza

*rodzaj materiału / kolor / nr artykułu / (nr artykułu z ws)*

ws = warstwa samoprzylepna

## Rodzaj materiału

CR	neopren
EP	EPDM
NBR	perbunan
NK	kauczuk naturalny
Si	silikon
SPS	pianka silikonowa
FPM	VITON®
PVC	zmiękczoney PCW
SBR	Buna (styren-butadien)

## Kolor

s	czarny
g	szary
w	biały
az	antracyt
bg	beżowy
br	brązowy
hg	jasno szary
rb	ceglasty
t	przezroczysty
r	czerwony
x	kolor do wyboru

VITON® = Zastrzeżony znak towarowy firmy DuPont

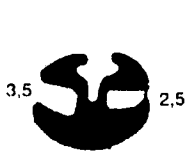

KL262



KL263



KL264

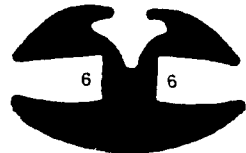

KL265



KL266

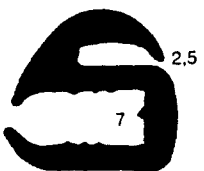

KL276



KL302

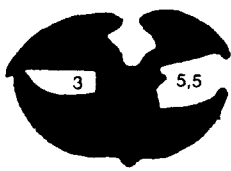

KL343

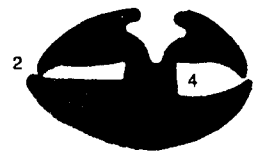

KL383Si

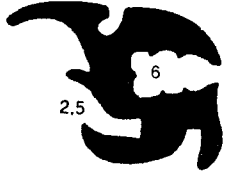

KL406



KL415

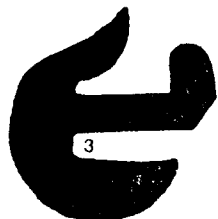

KL433

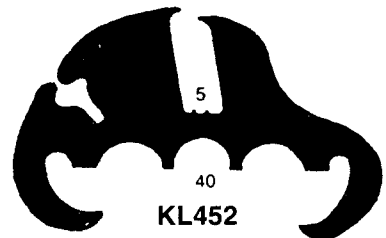

KL452

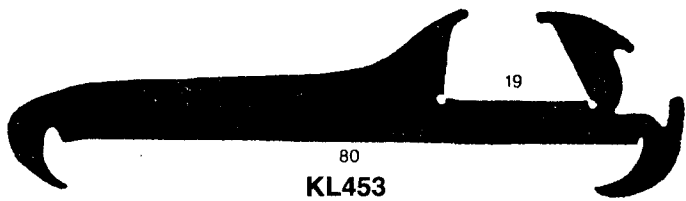

KL453

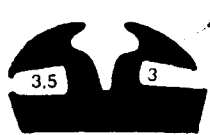

KL455



KL473/1

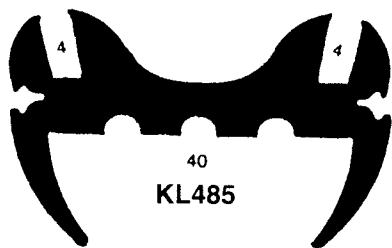

KL485



KL518Si

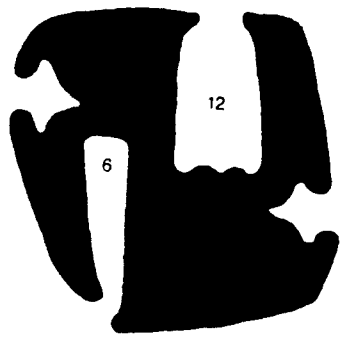

KL520

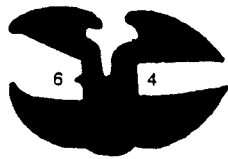

KL557

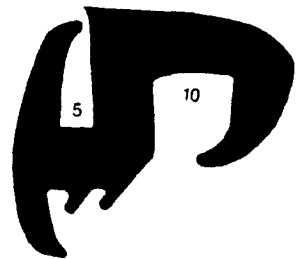

KL569

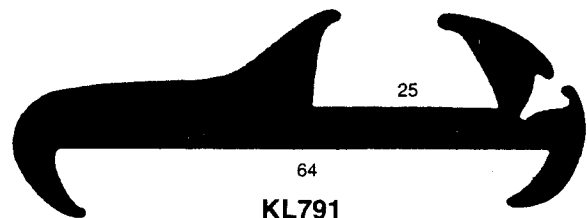

KL791

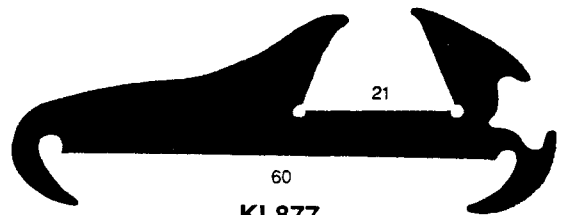

KL877



KL917

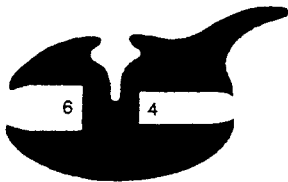

KL954

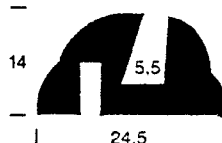

KL996



KL1093



KL1094

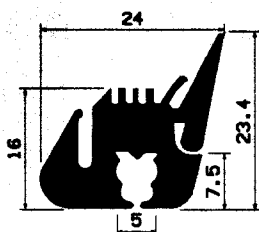

KL1309

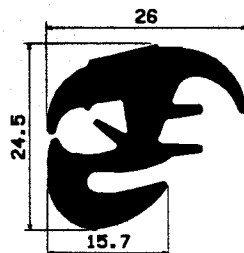

KL1356

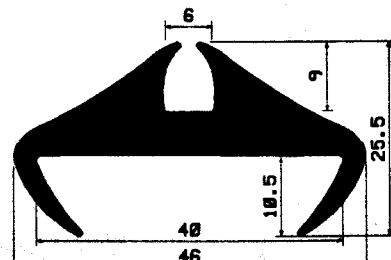

KL1365

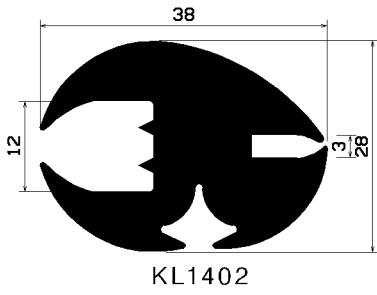

KL1402

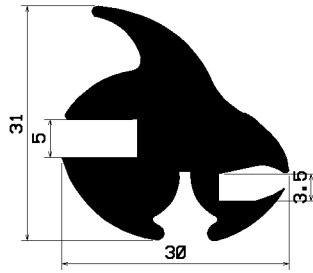

KL1428

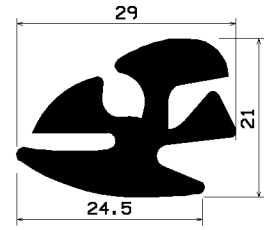

KL1460

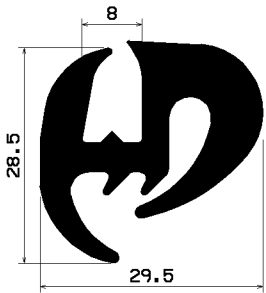

KL1532

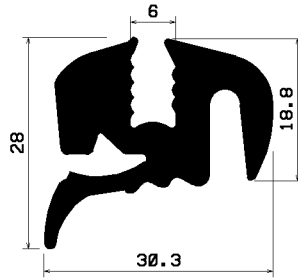

KL1706

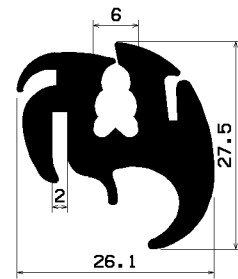

KL1727

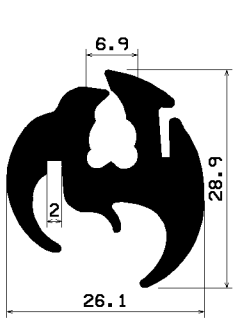

KL1779

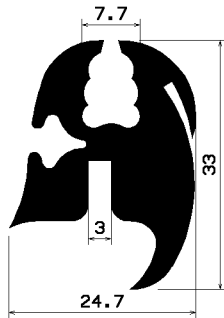

KL1788

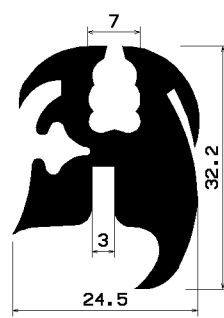

KL1792

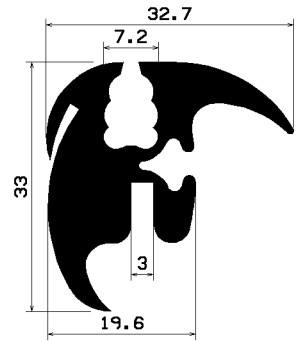

KL1793

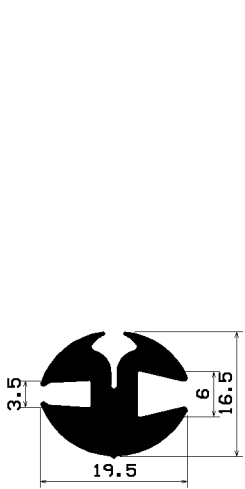

KL1834

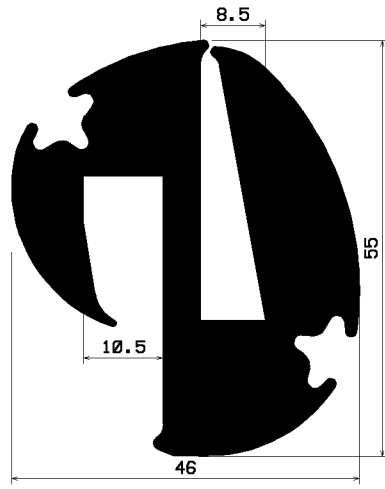

KL1844

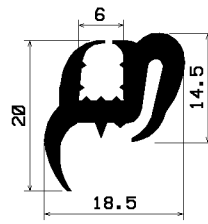

KL1912

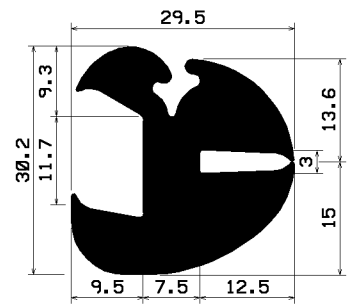

KL2071

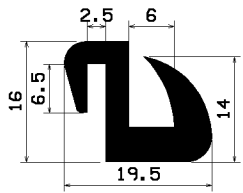

KL2162

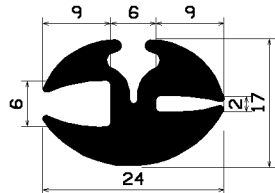

KL2168

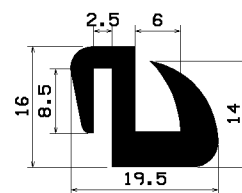

KL2200

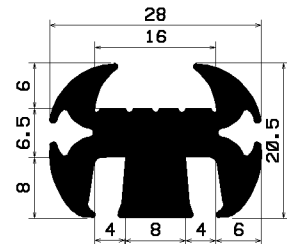

KL2216

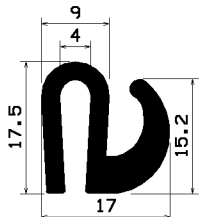

KL2270

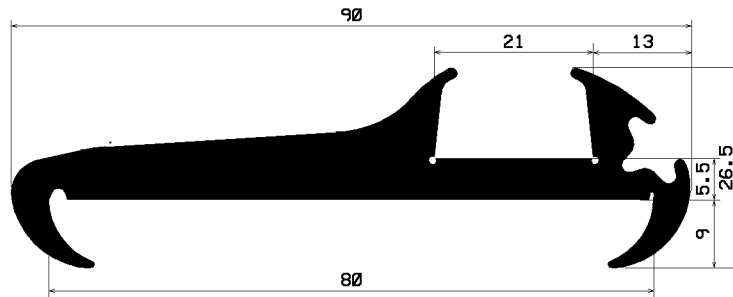

KL2336

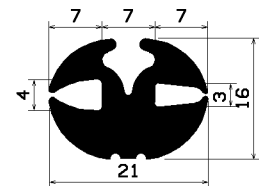

KL2400

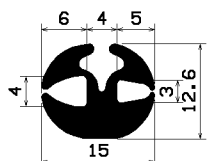

KL2402

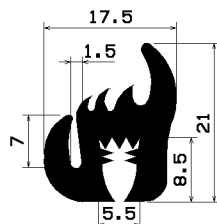

KL2427

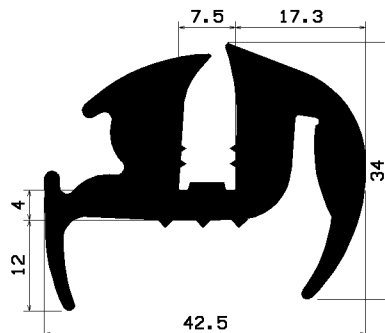

KL2469

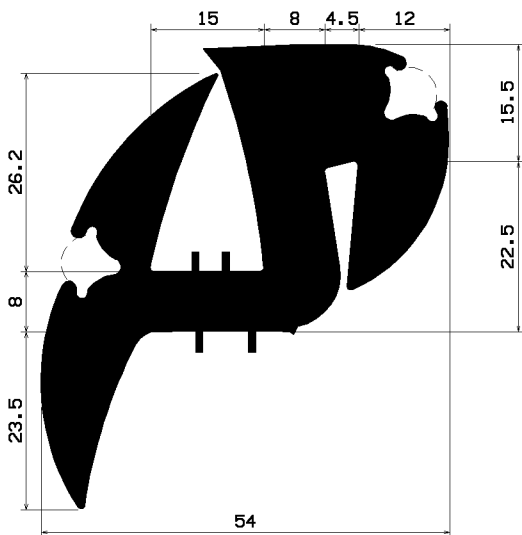

KL2487

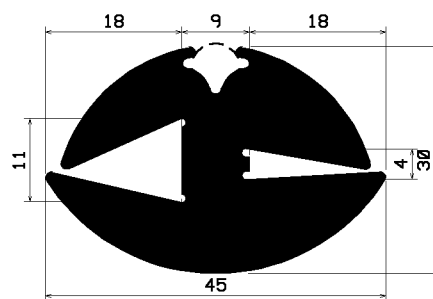

KL2498

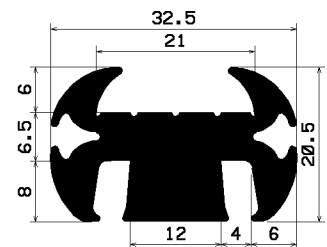

KL2541

# Profile rozpieracze

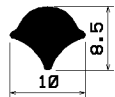

FR384  
Si/s/ 1652

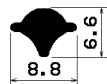

FR668  
PVC/s/ 1649  
EP/s/ 6955

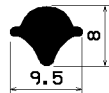

FR669  
EP/s/ 1651

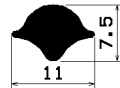

FR670  
EP/s/ 1650



FR985  
PVC/s/ 3322

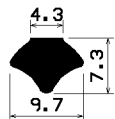

FR1545  
EP/s/ 4807

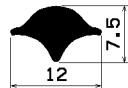

FR1708  
Si/x/ 5881

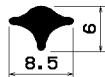

FR1835  
Si/x/ 6209



FR2236  
EP/s/ 7829