



---

---

# gummi-plast

Schild GmbH & Co.KG

Gernsheim

---

---



**Profile aus Gummi, Moosgummi,  
Silikon, Schaumsilikon**

D-64579 Gernsheim

Otto-Hahn-Straße 12

Telefon 0 62 58 / 932250

Telefax 0 62 58 / 4997

e-mail: [schild@gummi-plast.de](mailto:schild@gummi-plast.de)

internet: <http://www.gummi-plast.de>

## Profile fasadowe

## Lista nr 588



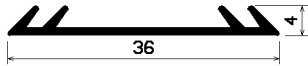

F119  
EP/s/1622

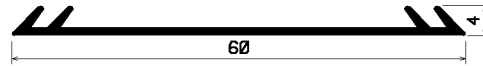

F120  
EP/s/1623

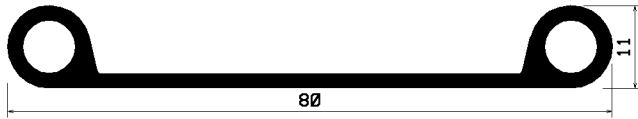

F220  
EP/s/1624

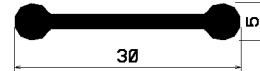

F287  
EP/s/1625

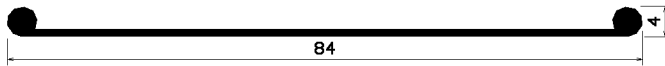

F310  
PVC/bg/1041

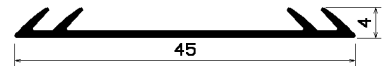

F330  
EP/s/1476/(1459)

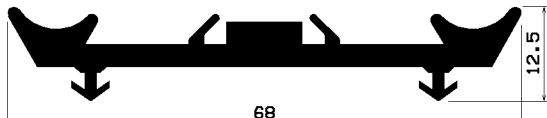

F336  
EP/s/1626

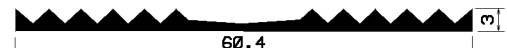

F358  
EP/s/1628  
EP/w/4032/(4309)



F361  
EP/s/1627

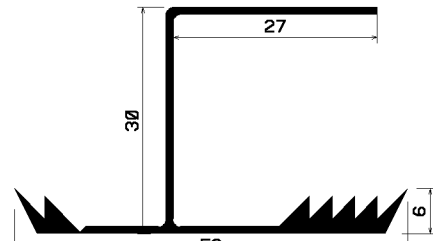

F399  
EP/s/1630

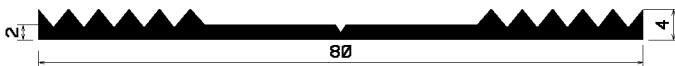

F400  
EP/s/1629



F414  
EP/s/1633/(4247)

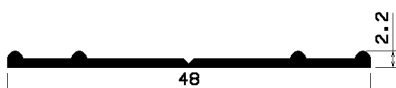

F417  
EP/s/1632

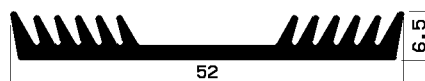

F419  
EP/s/1632



F457  
EP/s/1648/(1159)

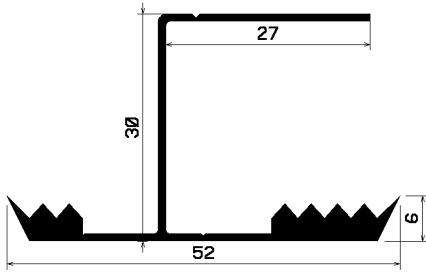

F459  
EP/s/1635

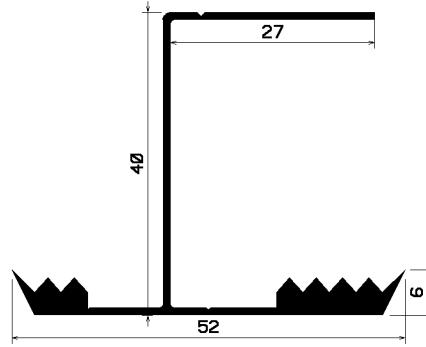

F460  
EP/s/1636

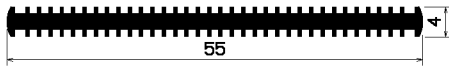

F475  
EP/s/1637

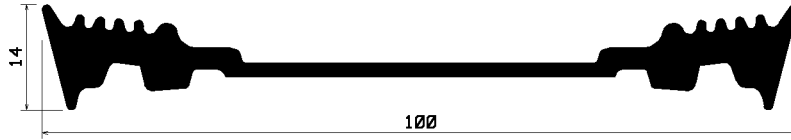

F482  
EP/s/1638

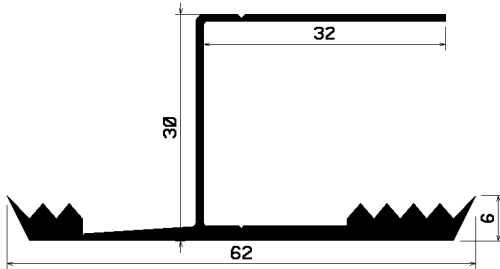

F546  
EP/s/1639

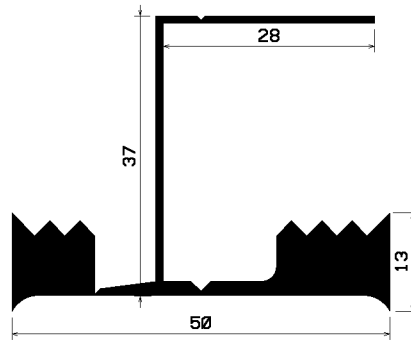

F554  
EP/s/1640

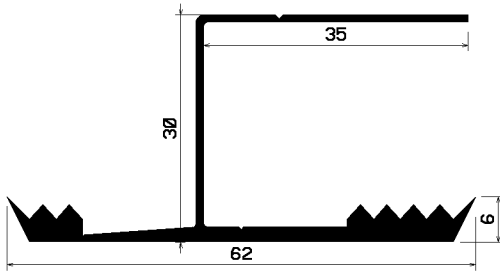

F555  
EP/s/1641

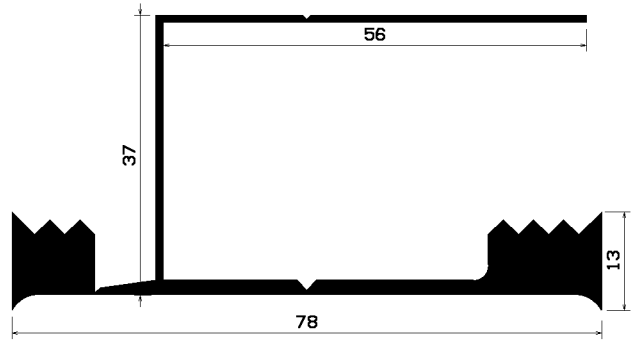

F562  
EP/s/1642

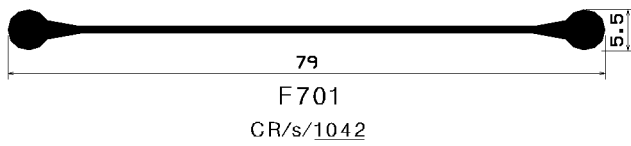
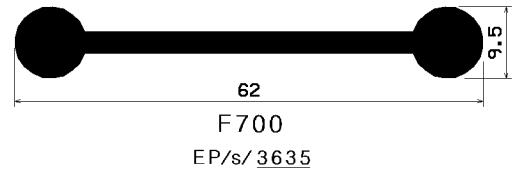
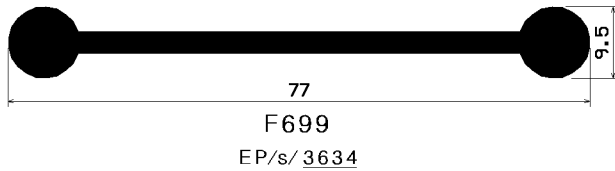
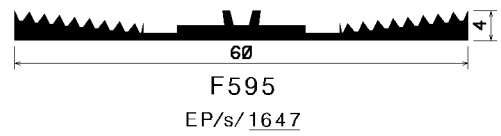
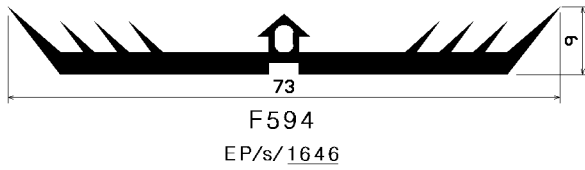
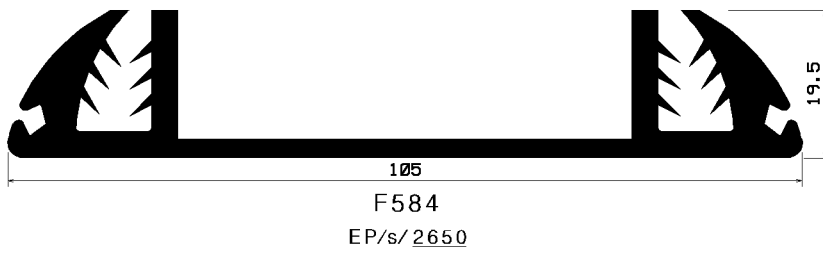
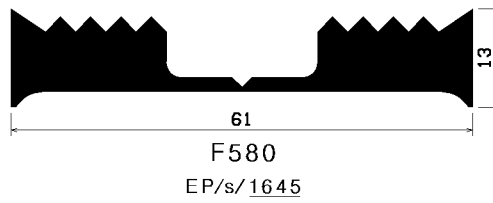
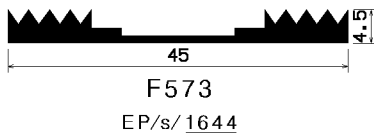
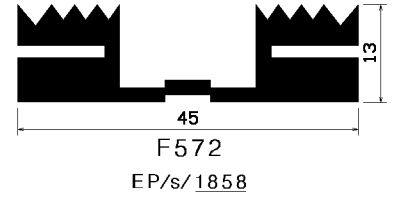
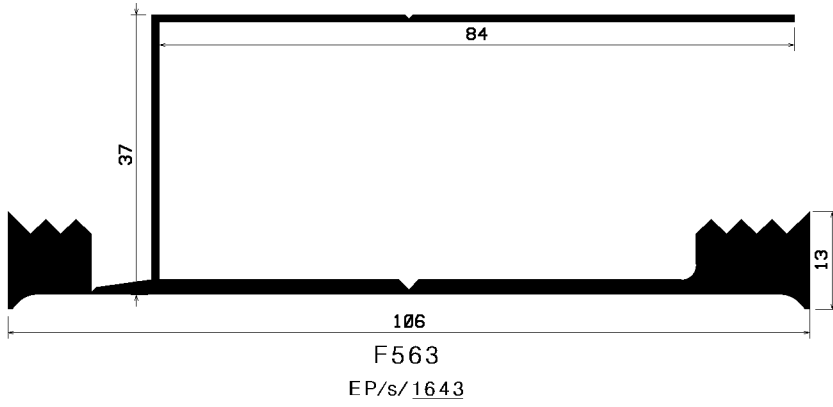

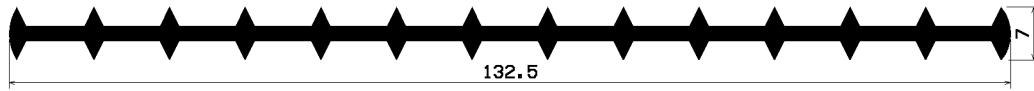

F702  
EP/s/4642

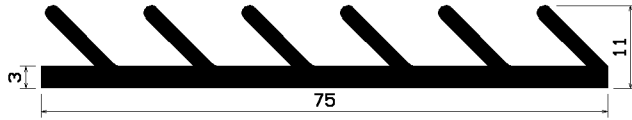

F703  
EP/s/1959

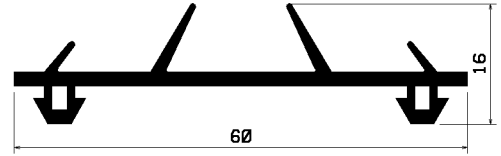

F704  
Si/s/1522



F707  
NK/s/5412



F708  
EP/s/1249

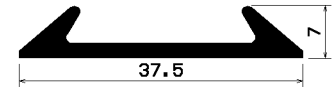

F709  
EP/s/1277/(4554)

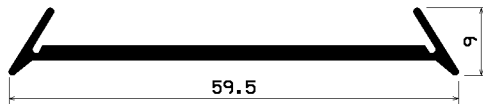

F711  
EP/s/5173

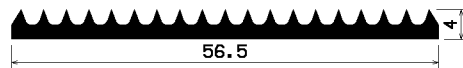

F712  
EP/s/1880

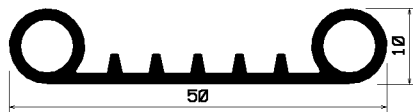

F713  
EP/s/4445

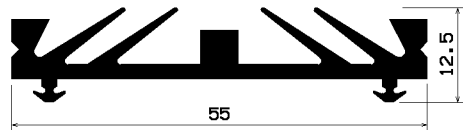

F714  
EP/s/1338



F715  
EP/s/6316

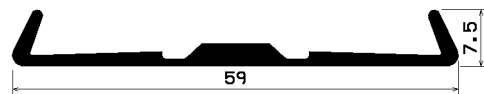

F717  
EP/s/4354



F719  
EP/s/ 4794



F725  
EP/s/ 1575

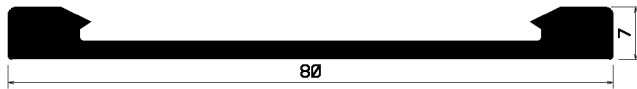

F727  
CR/s/ 4355

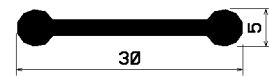

F837  
EP/s/ 2851

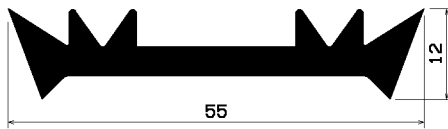

F916  
EP/s/ 3110

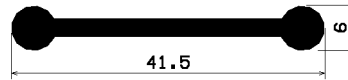

F922  
NBR/s/ 3129

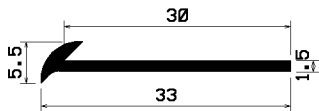

F925  
EP/s/ 3139

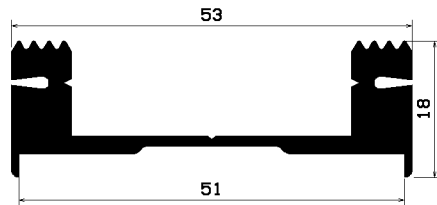

F929  
EP/s/ 3150

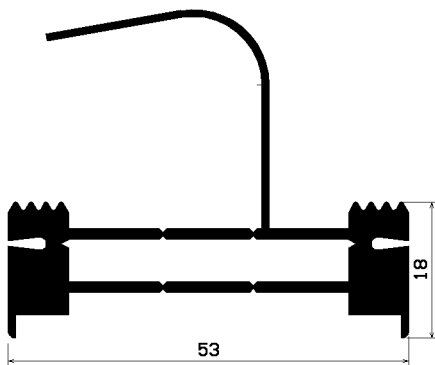

F930  
EP/s/ 3171

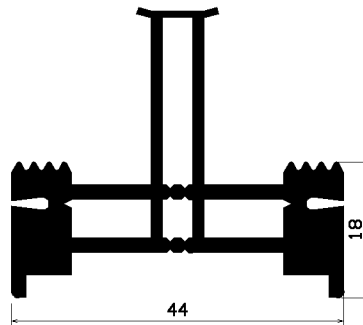

F981  
EP/s/ 3308

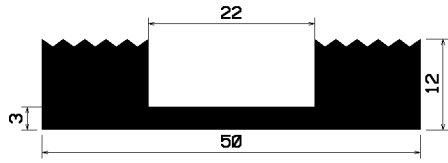

F984  
EP/s/3311

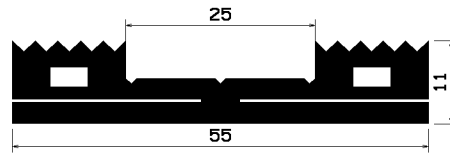

F1140  
EP/s/3763

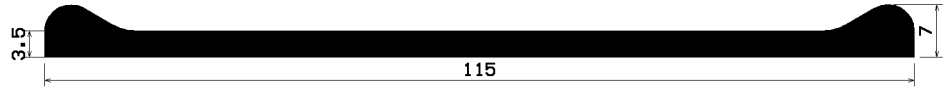

F1244  
EP/s/4064

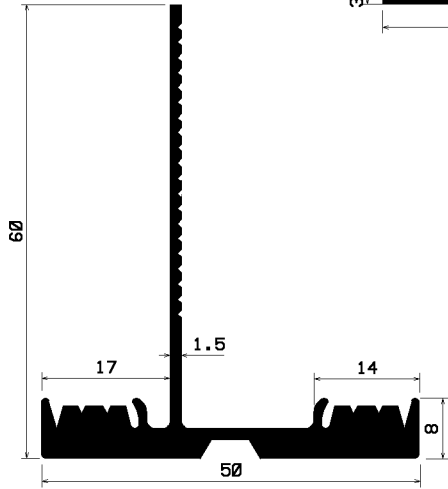

F1246  
EP/s/4067

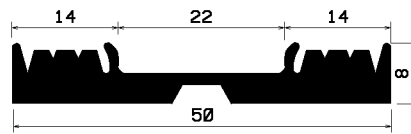

F1247  
EP/s/4068

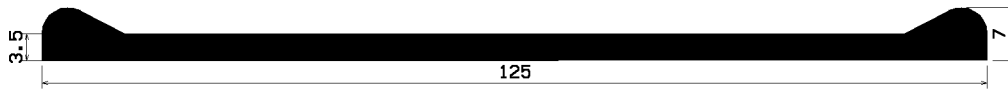

F1271  
EP/s/4137

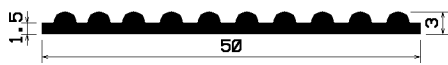

F1287  
EP/s/4190

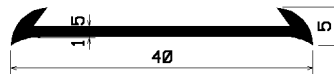

F1294  
EP/s/2286

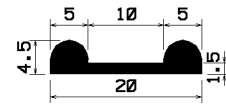

F1313  
EP/s/1033

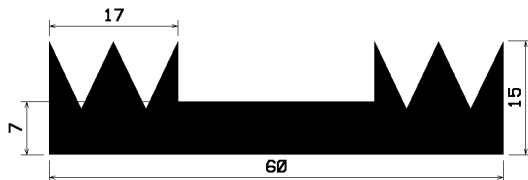

F1359  
SBR/s/1292

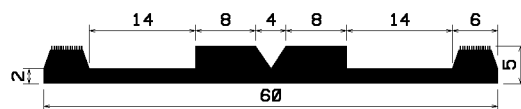

F1387  
EP/w/1882



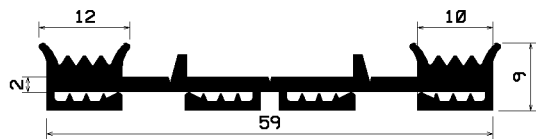

F1410  
EP/s/ 4231

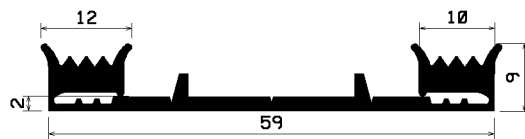

F1411  
EP/s/ 4233

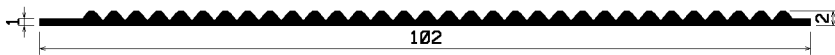

F1420  
EP/g/4276

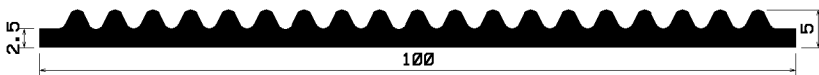

F1482  
CR/s/4627

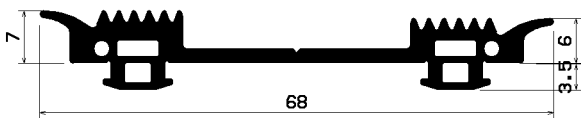

F1551  
EP/s/ 4828

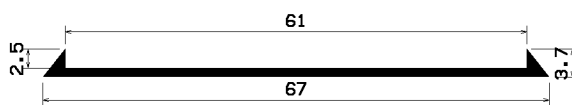

F1553  
NBR/s/ 4848

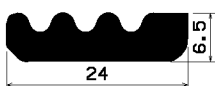

F1558  
EP/s/ 4891



F1591  
EP/s/ 5215/(5216)

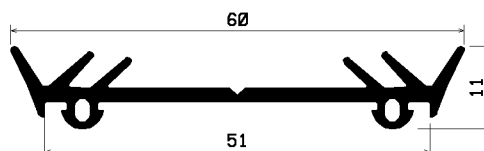

F1667  
EP/s/ 5659



F1771  
EP/s/ 6028

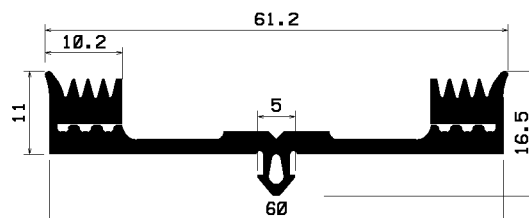

F1905  
EP/s/ 6776

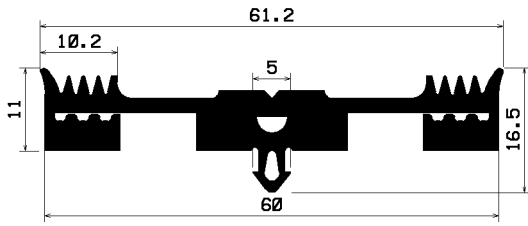

F1906  
EP/s/ 6777

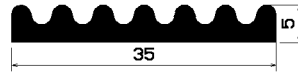

F1923  
NBR/s/ 6638

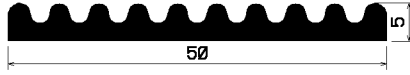

F1925  
NBR/s/ 6641

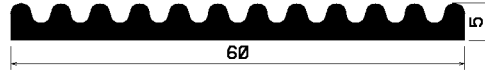

F1926  
NBR/s/ 6640

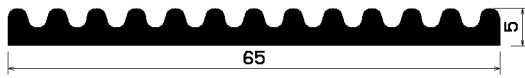

F1927  
NBR/s/ 6639

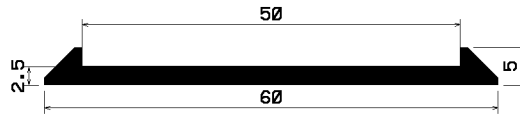

F1937  
Si/I/ 6671

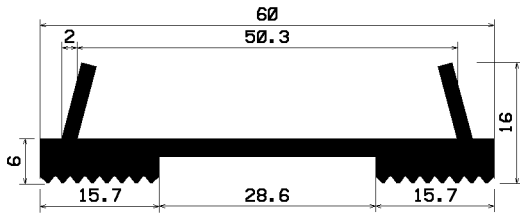

F2005  
EP/s/ 7007

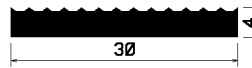

F2171  
EP/s/ 7619

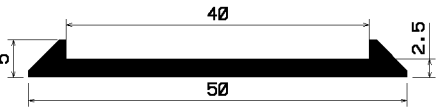

F2172  
EP/s/ 7623

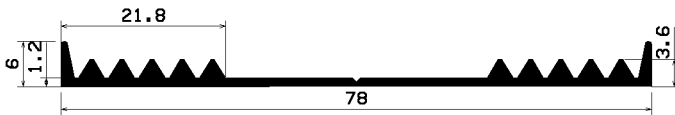

F2174  
EP/s/ 7634

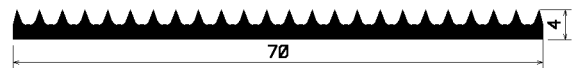

F2248  
EP/g/ 7853

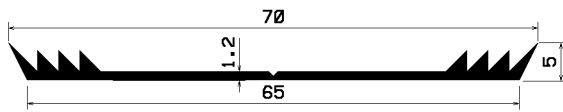

F2276  
EP/s/ 7962

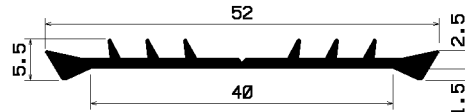

F2458  
EP/s/ 7423

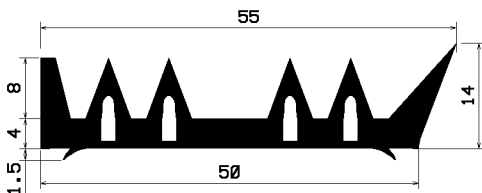

F2468  
EP/s/ 7449

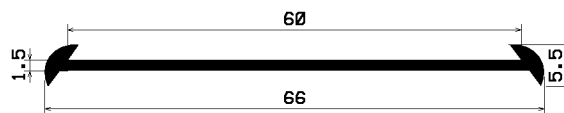

F2479  
EP/s/ 7497

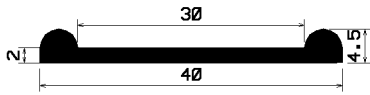

F2490  
EP/s/7523



F2545  
EP/s/8646

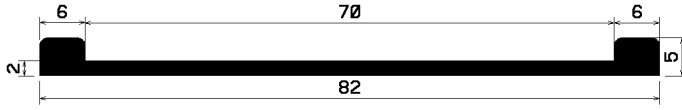

F2618  
NBR/s/8819