

PROFILE, SZNURY
I KSZTAŁTKI Z GUMY,
SILIKONU, GUMY
POROWATEJ
I SILIKONU
SPIENIONEGO
(POROWATEGO)

specGUM Sp. z o.o.
93-231 Łódź, ul. Gen. J. Dąbrowskiego 238
tel.: 42 236 14 15, fax: 42 682 13 00
info@specgum.pl, www.specgum.pl
NIP: 729-26-49-106, Regon: 100545771
KRS: 0000310107

Ostony szczelin i profile typu T Lista nr 628

Ostatnia zmiana: 20.04.2008

FA / T

Guma lita

Objaśnienie oznaczeń

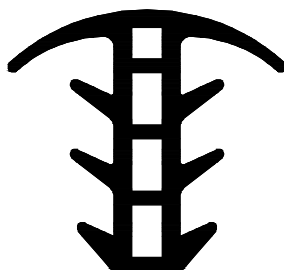

FA 9999

oznacza

nr profilu

EP / s / 9999

oznacza

rodzaj materiału / kolor / nr artykułu /

Rodzaj materiału

CR	neopren
EP	EPDM
NBR	perbunan
NK	kauczuk naturalny
Si	silikon
SPS	pianka silikonowa
FPM	VITON®
PVC	zmiękczone PCW
SBR	Buna (styren-butadien)
TPE	elastomer termoplastyczny

Kolor

s	czarny
g	szary
w	biały
az	antracyt
bg	beżowy
br	brązowy
hg	jasno szary
rb	ceglasty
t	przezroczysty
r	czerwony
x	kolor do wyboru

® = Zastrzeżony znak towarowy firmy DuPont

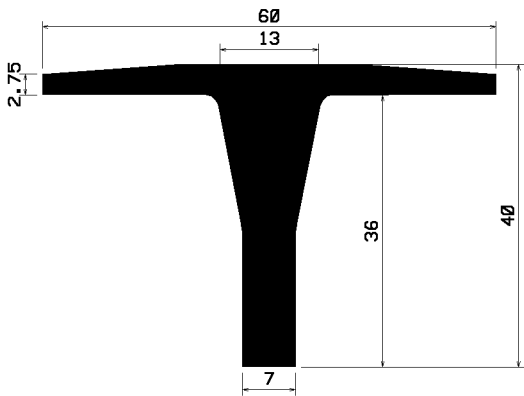

FA235
EP/s/ 2035

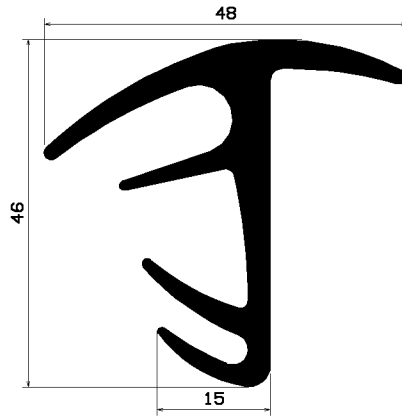

FA271
EP/s/ 2593

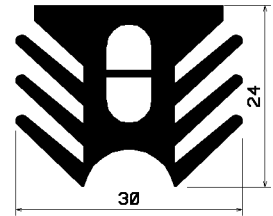

FA398
EP/s/ 2721

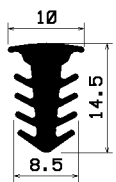

FA461
EP/s/ 7105

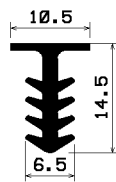

FA491
EP/s/ 2885

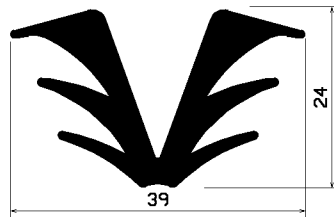

FA537
EP/s/ 2877

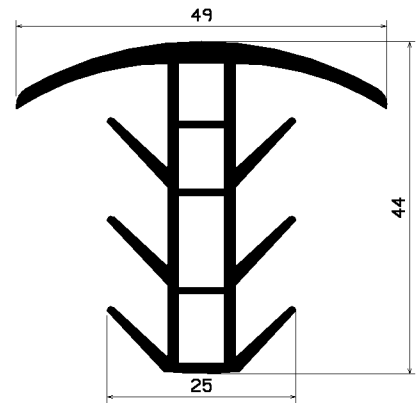

FA636
TPE/s/ 3383
EP/s/ 7858

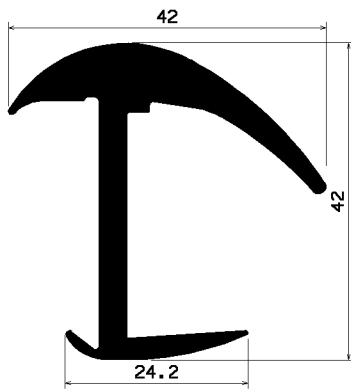

FA740
EP/s/ 2124

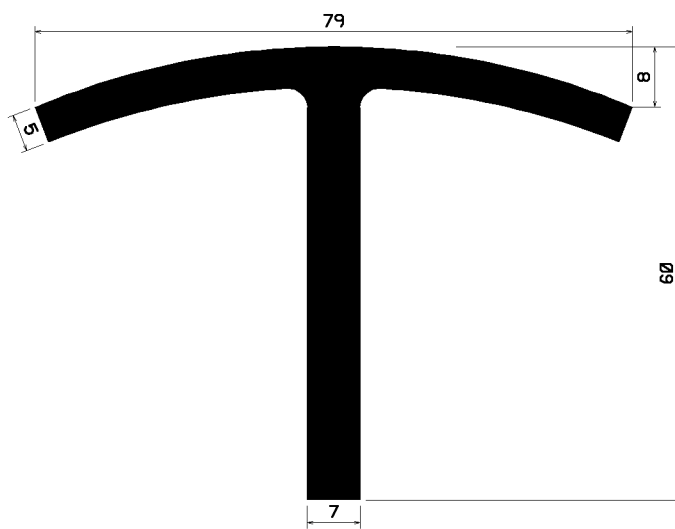

FA742
EP/s/ 2175

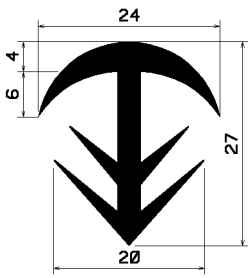

FA748
EP/s/ 2196

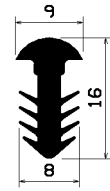

FA839
EP/s/ 2864

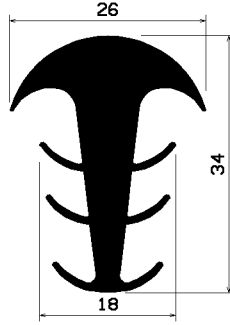

FA840
EP/s/ 2865

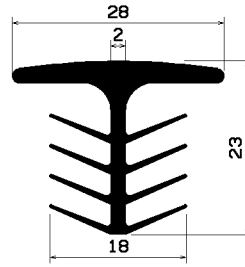

FA904
EP/s/ 8027

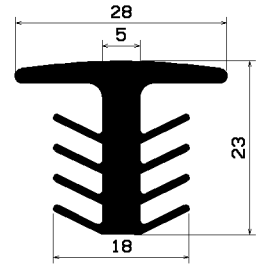

FA904/2
Si/t/ 3086

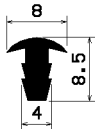

FA950
EP/s/ 3218

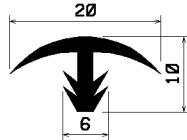

FA998
Si/t/ 3338
Si/w/ 3404
Si/g/ 3640
Si/s/ 3802

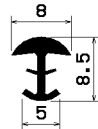

FA1027
EP/s/ 3403

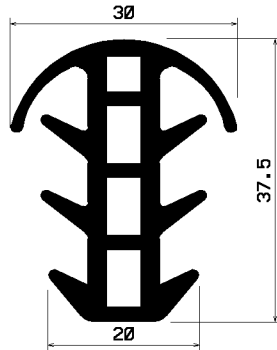

FA1053
EP/s/ 3455

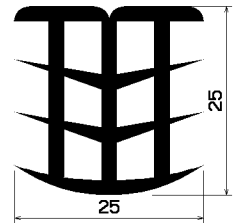

FA1081
EP/s/ 3600

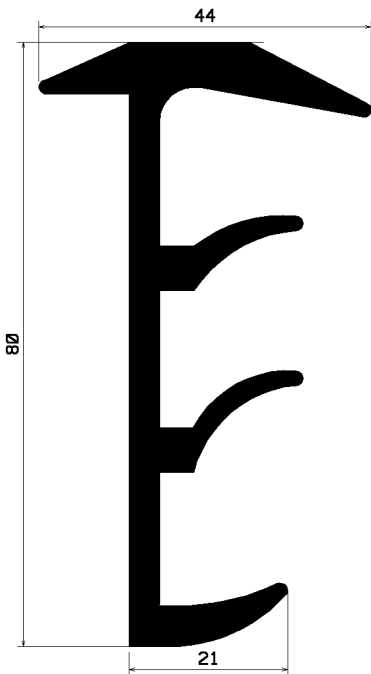

FA1207
EP/s/ 3967

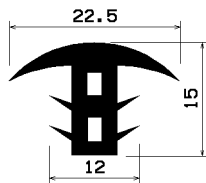

FA1221
EP/s/ 4014

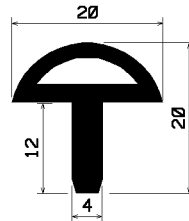

FA1239
EP/s/ 4060

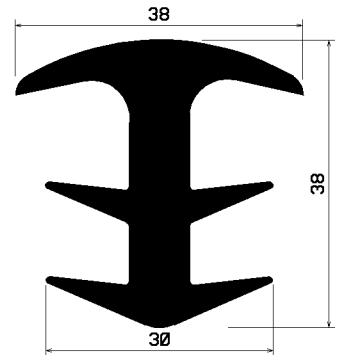

FA1253
EP/g/ 4098

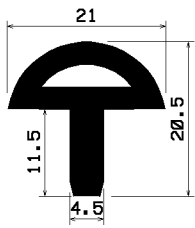

FA1267
EP/s/ 4142

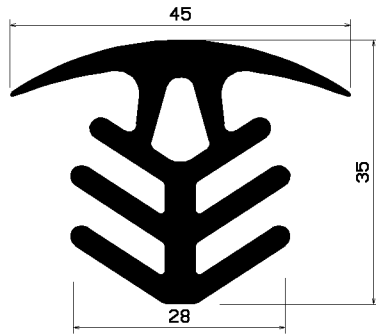

FA1349
EP/g/ 1191

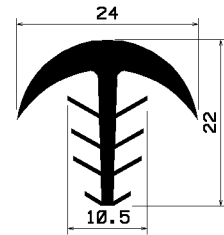

FA1437
CR/s/ 3480

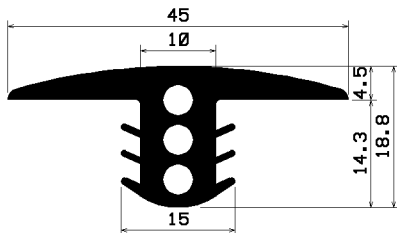

FA1457
PVC/or/4536
PVC/bl/4537
NBR/s/ 6799

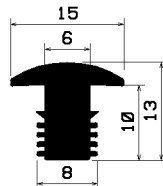

FA1471
EP/s/ 4603

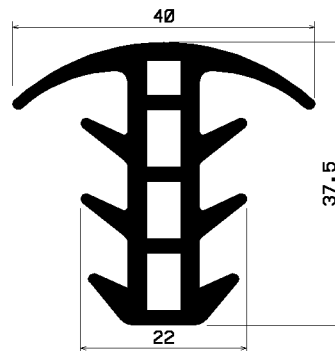

FA1479
EP/s/ 4700

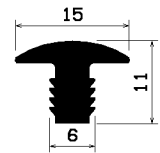

FA1486
EP/s/ 4666

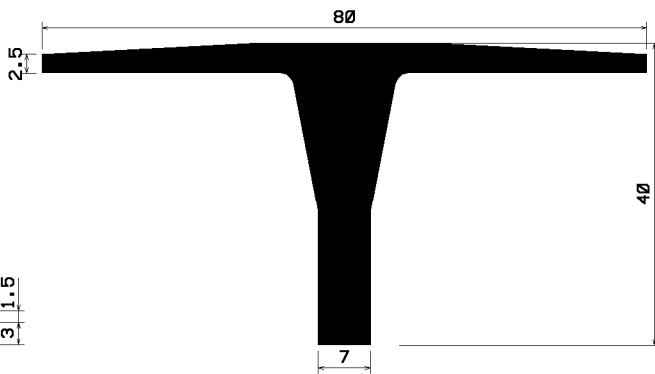

FA1550
EP/s/ 4773

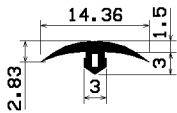

FA1526
EP/s/ 5729

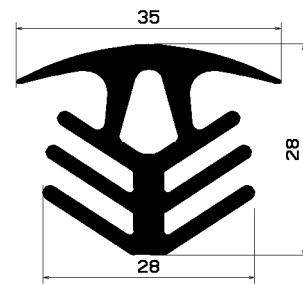

FA1559
EP/s/ 4888

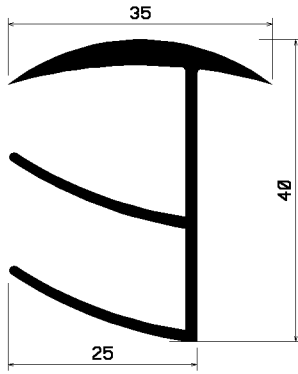

FA1560
EP/s/ 4998

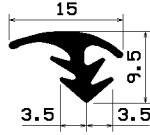

FA1675
EP/s/ 5726

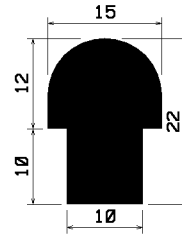

FA1701
Si/V/ 5776

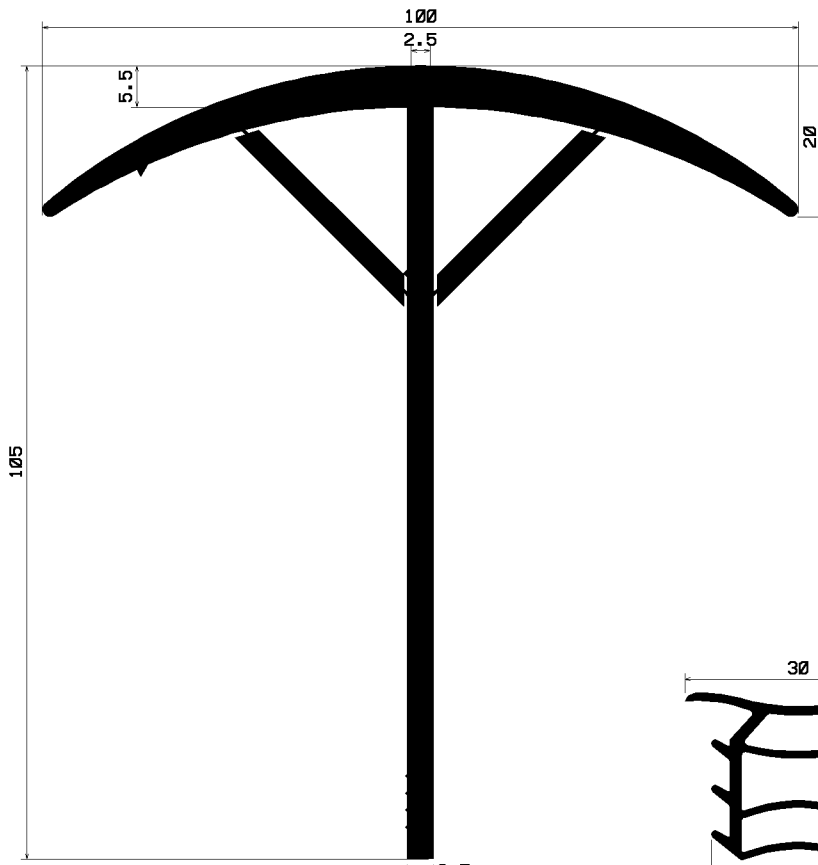

FA1711
EP/s/ 5860

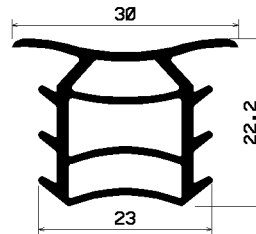

FA1717
EP/s/ 5859

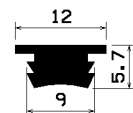

FA1742
Si/V/ 5967

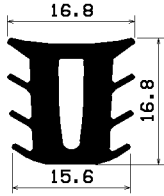

FA1829
EP/s/ 6204

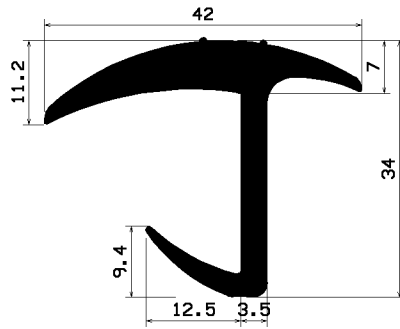

FA1945
EP/s/ 6840

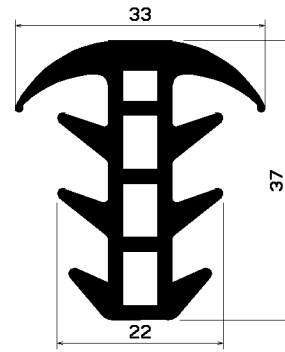

FA1982
EP/s/ 6936

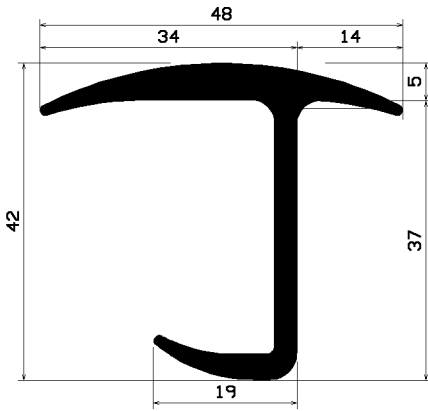

FA2050
EP/s/ 7115

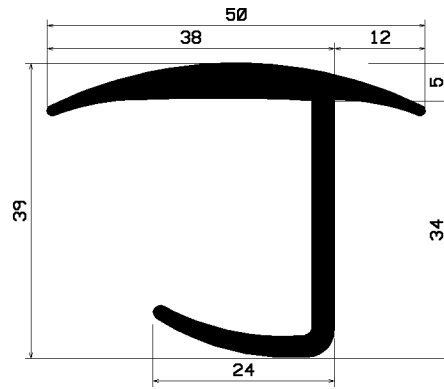

FA2051
EP/s/ 7116

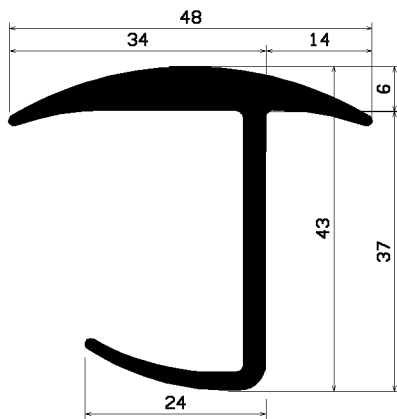

FA2052
EP/s/ 7117

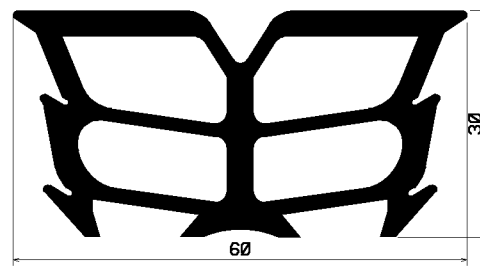

FA2068
EP/s/ 7167

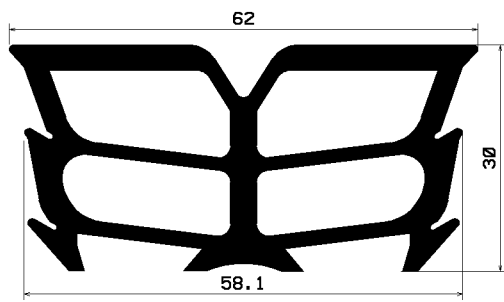

FA2087
EP/s/ 7241

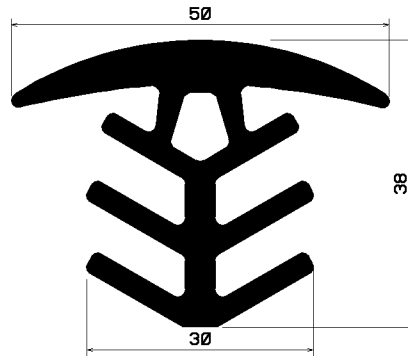

FA2102
EP/s/ 7271

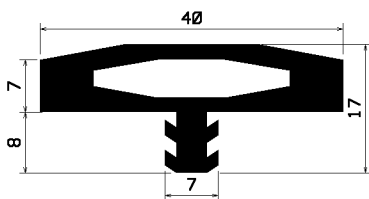

FA2114
Si/1/ 7303

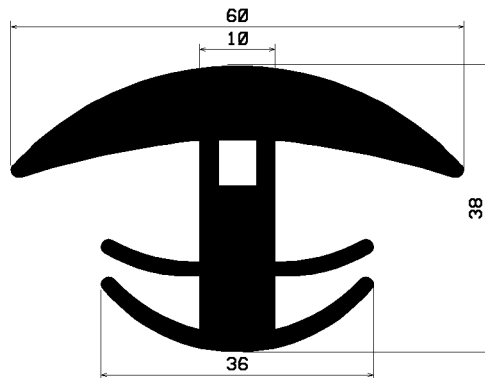

FA2169
EP/s/ 7621

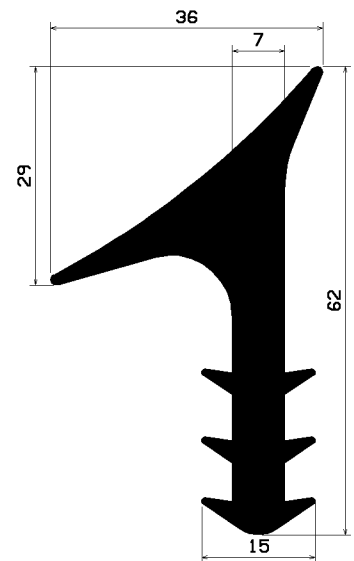

FA2247
EP/s/ 7851

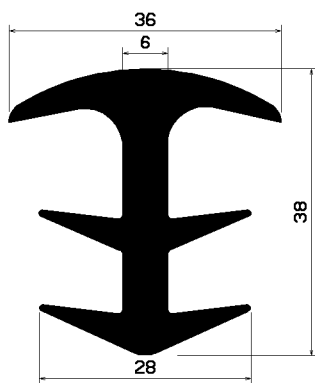

FA2285
EP/s/ 7980

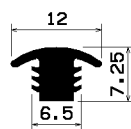

FA2300
EP/s/ 8065

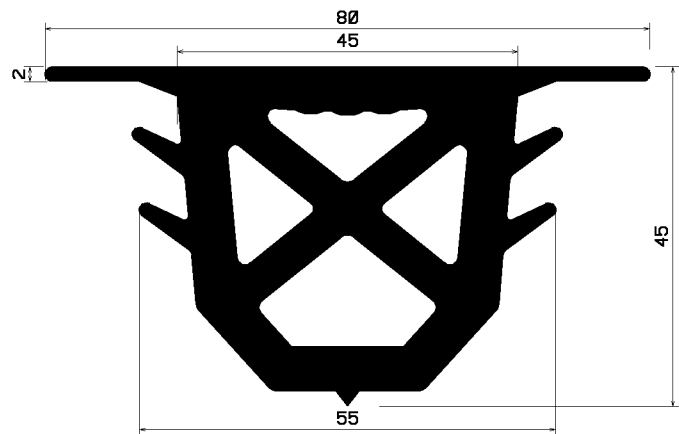

FA2328
EP/s/ 8103

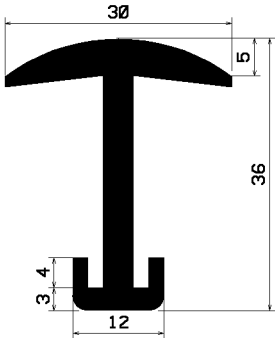

FA2409
EP/s/ 8285

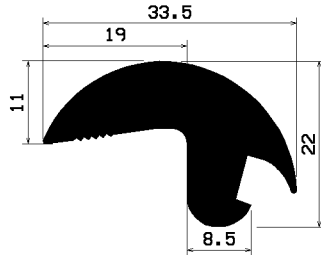

FA2420
EP/s/ 8318

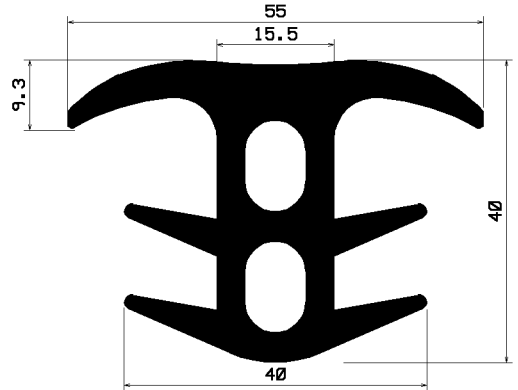

FA2470
EP/s/ 7451

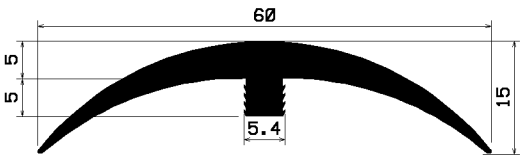

FA2475
PVC/s/7493

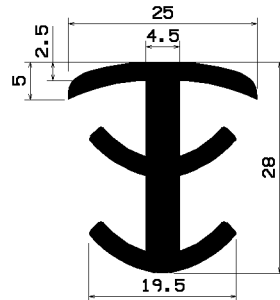

FA2501
EP/s/ 8392

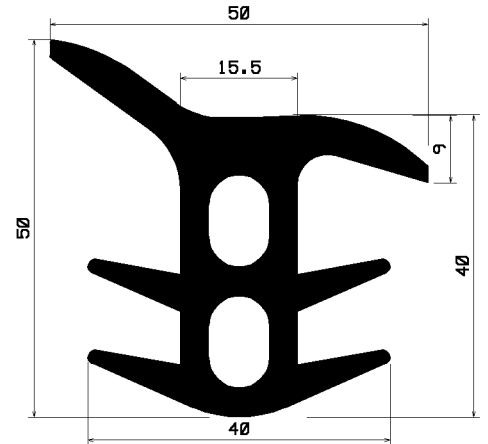

FA2514
EP/s/ 8426

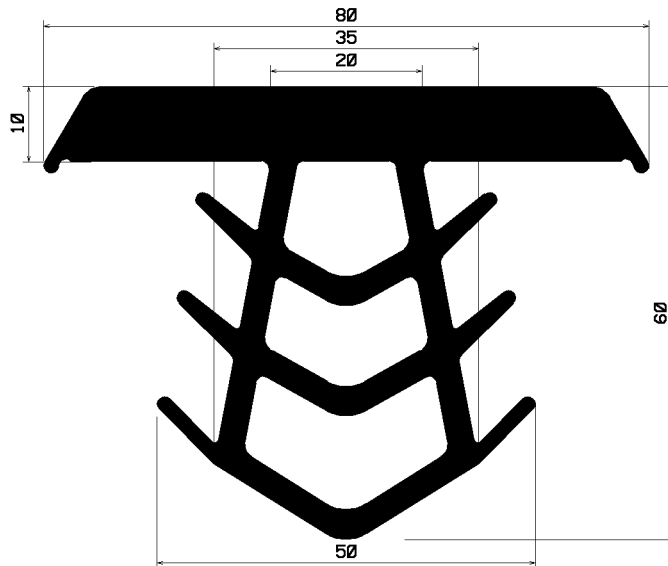

FA2544
EP/s/ 8638

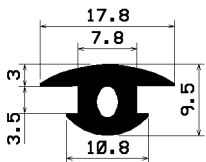

FA2533
EP/s/ 8592

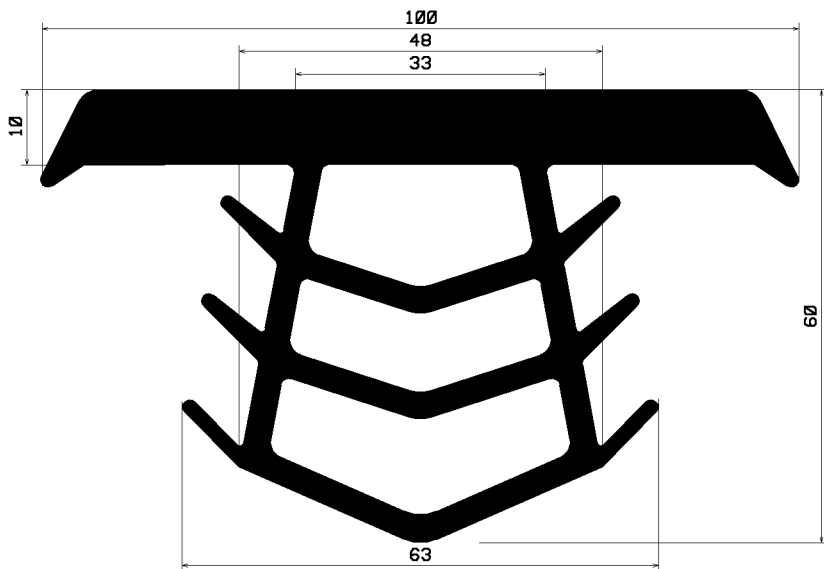

FA2548
EP/s/ 8639

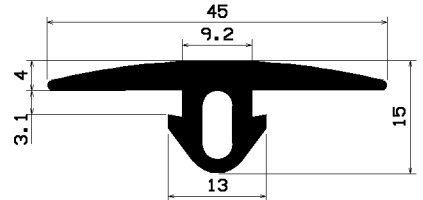

FA2609
EP/s/ xxxx

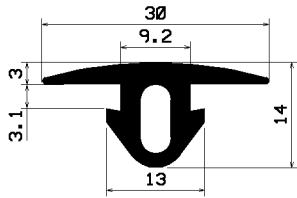

FA2610
EP/s/ xxxx

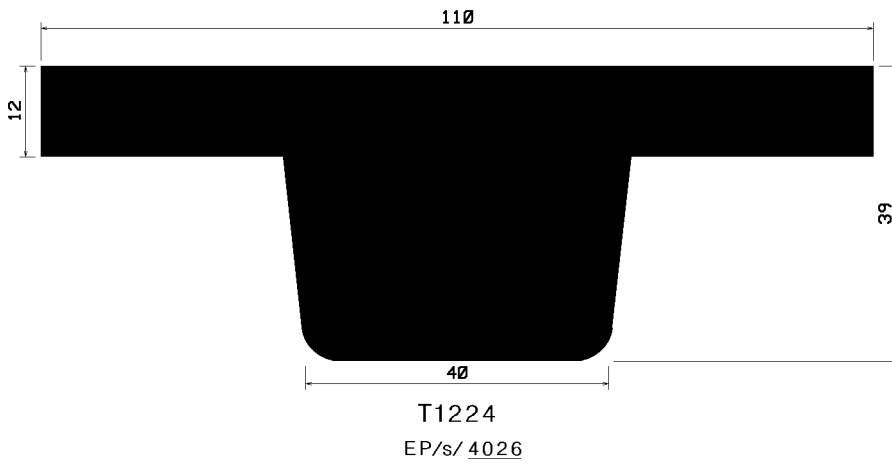
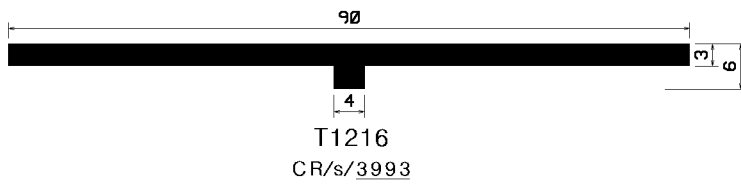
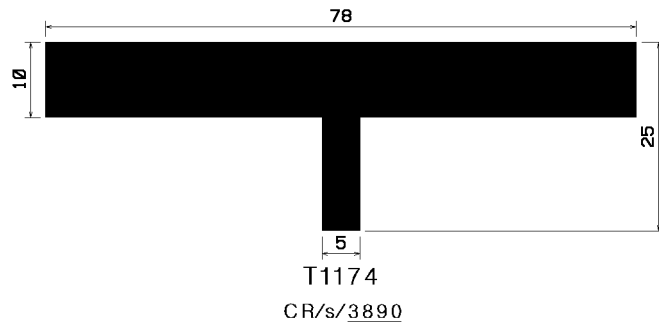
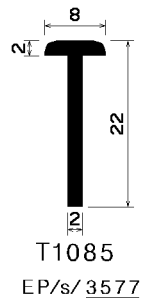
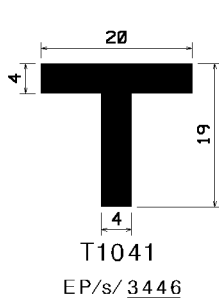
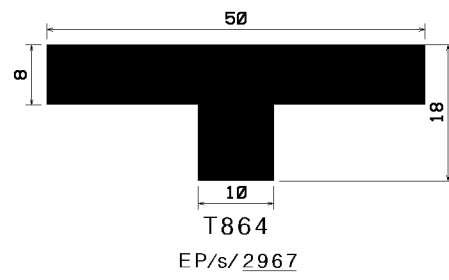
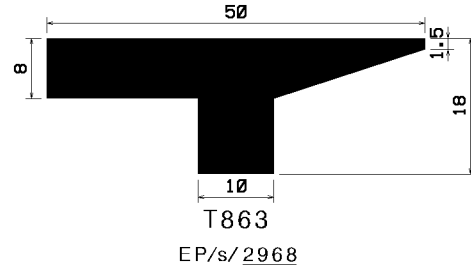
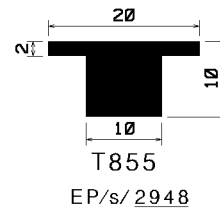
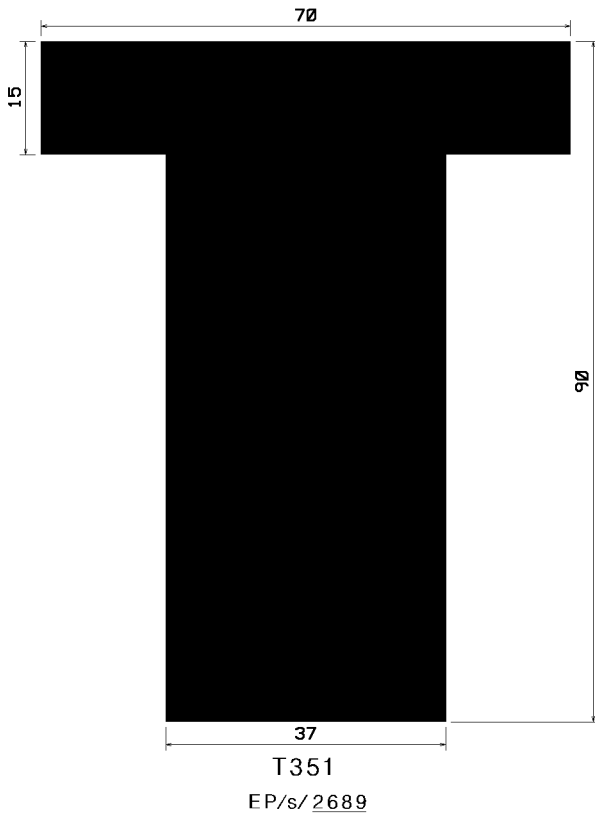

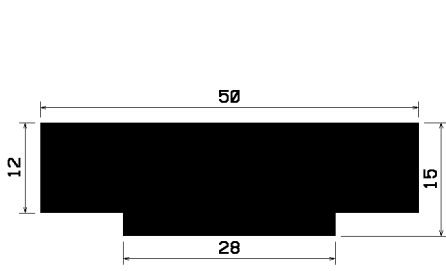

T1311
Si/V/ 0306

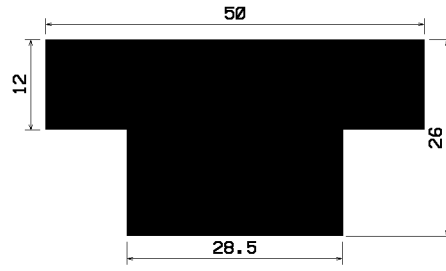

T1389
Si/V/ 1874

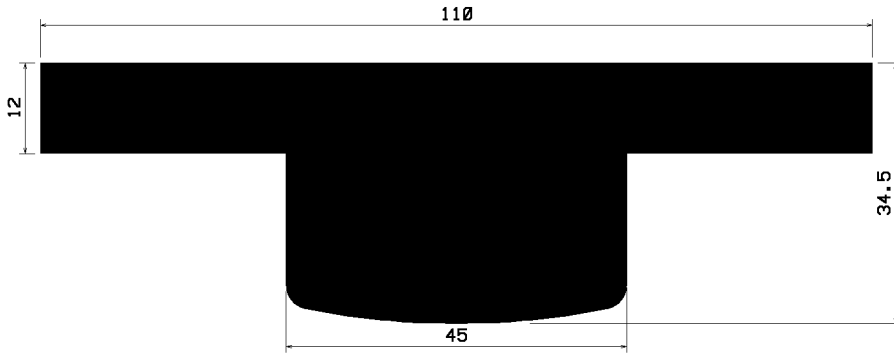

T1405
CR/s/1433

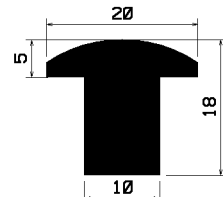

T1520
NBR/s/ 4745

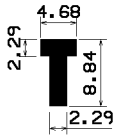

T1647
Si/s/ 5471

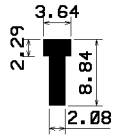

T1648
Si/s/ 5472

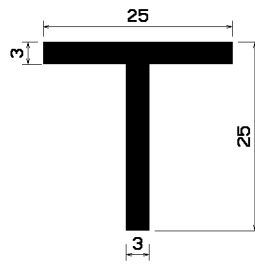

T1674
EP/s/ 5687

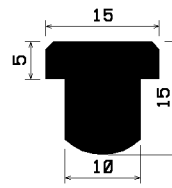

T1681
EP/s/ 5709

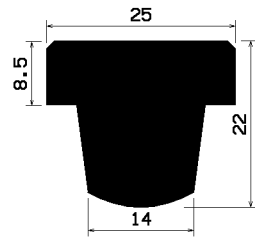

T1682
EP/s/ 5710

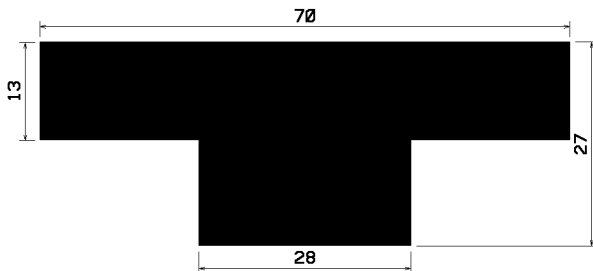

T1707
Si/V/ 5818

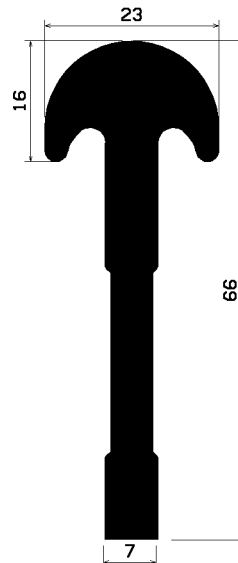

T1782
EP/s/ 6076

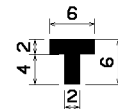

T1940
Si/V/ 6838

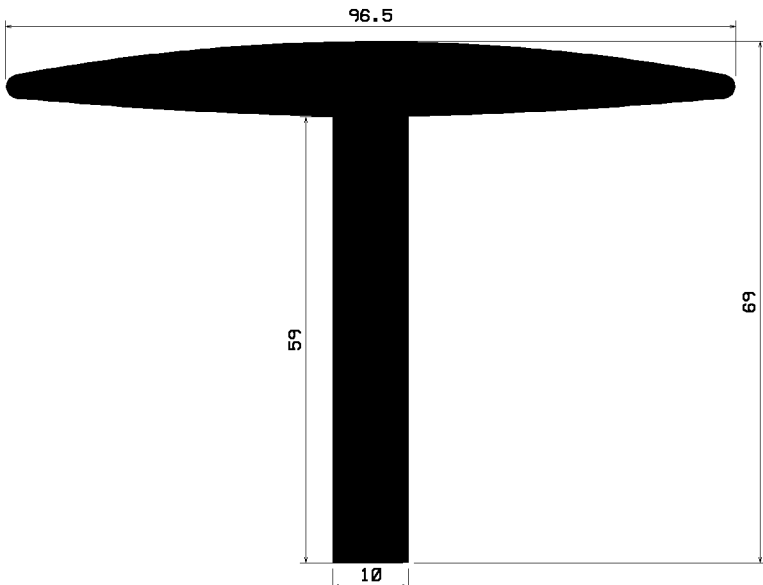

T1970
EP/s/ 6876

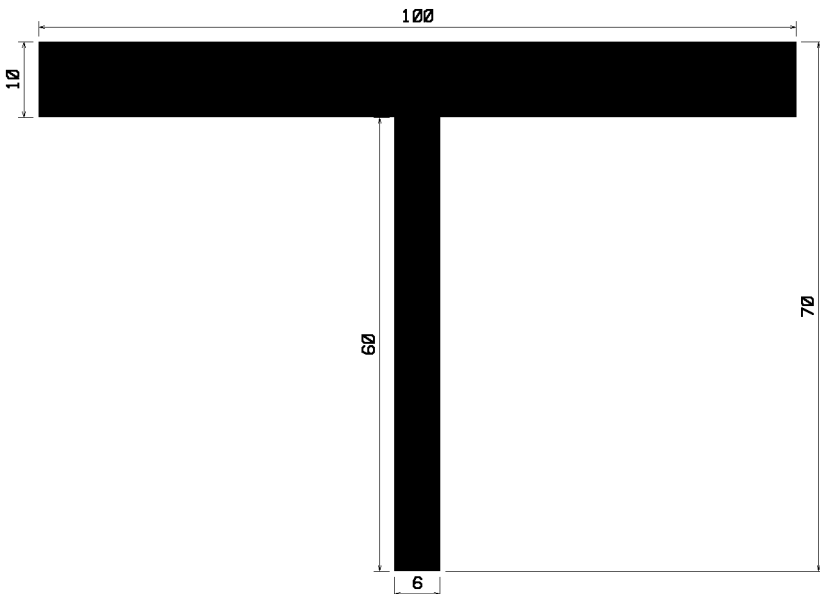

T1981
EP/s/ 6932

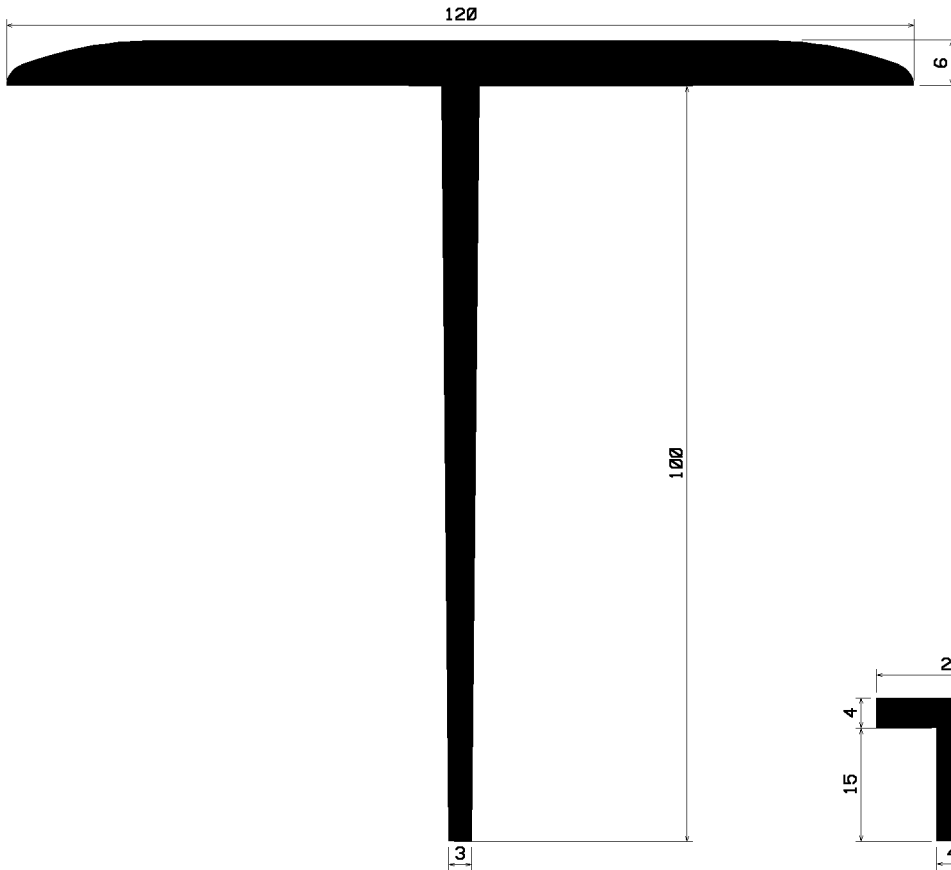

T2100
EP/s/ 7267

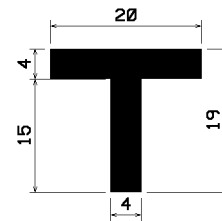

T2257
EP/s/ 7899

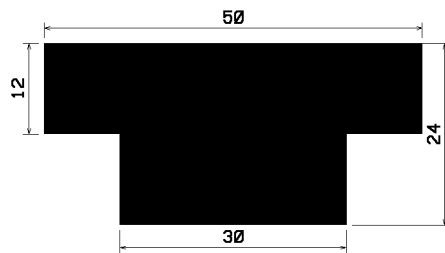

T2353
EP/s/ 8154

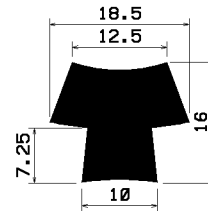

T2419
EP/s/ 8316

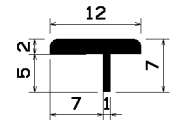

T2452
EP/s/ 7440

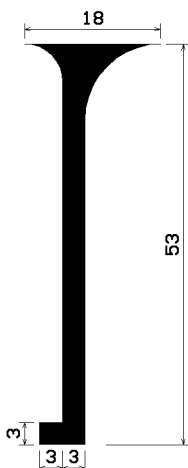

T2481
EP/s/ 7509

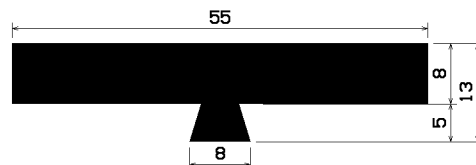

T2511
EP/s/ 8420

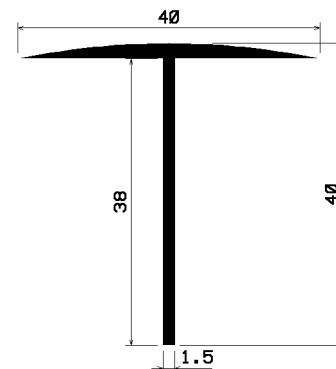

T2619
EP/s/ 8738